

2006D24

D24H36 L9

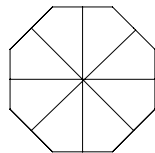
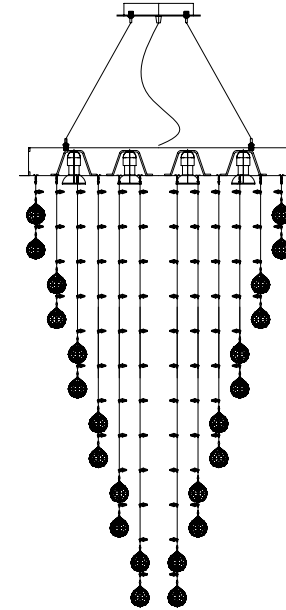

We are dedicated to providing the finest quality crystal chandelier for our customers. Our master craftsmen and designer pride themselves on their attention to detail. prompt, efficient service is our priority.

Enclosed, are detailed instructions on how to properly install your chandelier. Please read all instructions carefully and thoroughly. If you have any questions please feel free to call our toll free CHANDELIER HOTLINE AT:

1-888-388-3390



WARNING!!!

CONTENTS ARE FRAGILE HANDLE WITH CARE

The metal frame and crystal components of this chandelier are very delicate. Please exercise extreme caution during unpacking and installation.

WARNING!!!

After passing the main electrical wire through the 10mm pipe and connecting the pipe to the main body top connector, place all remaining pieces as shown in numerical order and in the orientation depicted. Refer to the parts list to avoid confusion between parts. The part numbers coincide.

CAUTION

1. Rated 110–130V/60Hz, bulb 40W maximum
2. Care should be taken to avoid damage to the surface of lighting and wire, wearing gloves is recommended when installing.
3. Connect black or red wire of the lighting to live wire and white or blue wire to neutral wire and double colored (or bare copper) wire to ground wire.
4. Never install lighting on damp ceiling, the room should be dry and well ventilated.
5. Keep lighting away from acid, alkali and other corrosive chemical or gas, clean the lighting with clean soft cloth only.
6. Installation must be carried out by qualified electrician only.
7. Disconnect the power before installing, cleaning and replacing lighting.
8. Never cover the lighting when power is connected.
9. Firmness must be secured when installing ceiling tube, chain, pipe and other connecting parts.
10. Care should be taken to avoid damage when installing glass parts.
11. All electrical components must be installed by a licensed electrician and in accordance with the National Electrical Code and the appropriate local electrical codes. Make sure that the electrical supply to the chandelier is turned off at the main fuse or circuit breaker before doing any installation.

CANOPY PARTS LIST

ZA: Junction Box (not supplied)

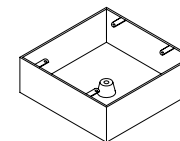

ZB: Crossbar

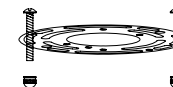

ZC: Crossbar Screw x 2 (not supplied)

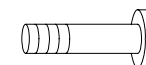

ZD: Metal plate

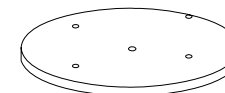

ZE: Screw Cap



ZF: Electric Main



ZG: Junction Cap



CANOPY INSTALLATION DIAGRAM

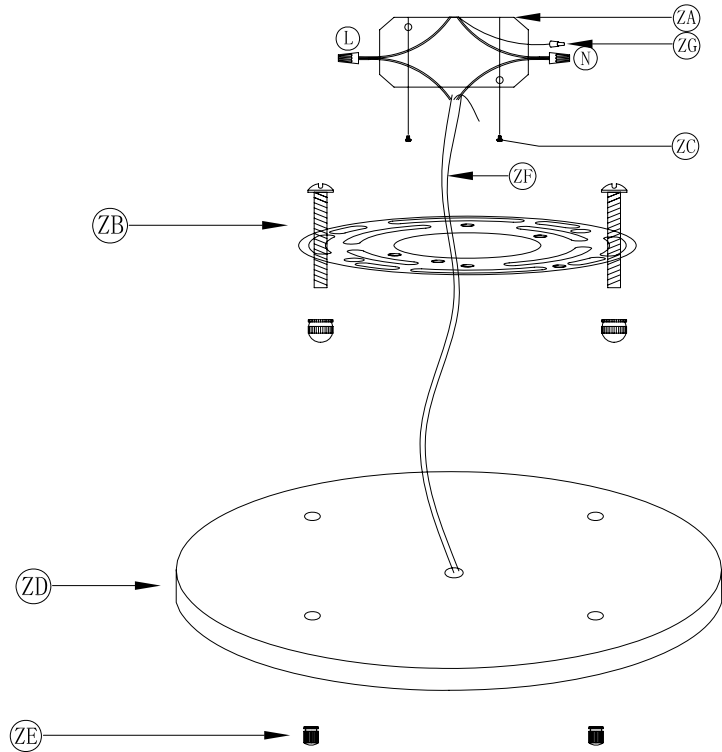

CANOPY INSTALLATION INSTRUCTIONS

Please read all instructions carefully. Before you proceed to install, make sure that the power supply is tamed off and off until installation is complete. Please note that each part has been assigned a letter. Please proceed in alphabetical order.

- ZA. Junction Box (not supplied)
- ZB. Crossbar
- ZC. Crossbar Screw
- ZD. Metal plate
- ZE. Screw Cap
- ZF. Electric Main
- ZG. Junction Cap

1. Fasten crossbar (ZB) into the junction box (ZA) with crossbar screws (ZC).
2. Connect the hot wire, neutral wire and ground wire correctly and tighten them with junction caps (ZG).
3. Fix the canopy and tighten it with screw caps (ZE).

Frame Assembly Diagram

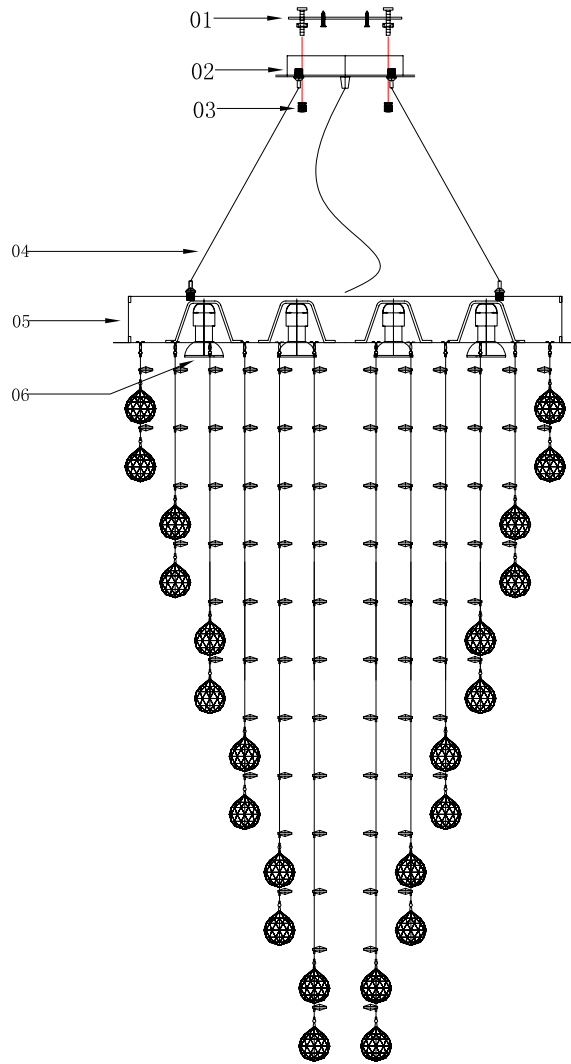

05

Frame Parts List



01-Crossbar*1PC

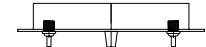

02-Metal Plate*1PC



03-Screw Cap*4PCS



04-Steel Wire*4PCS

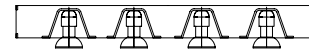

05-Lamp body*1PC



06-Gu10 light*9PCS

06

Frame Assembly Instructions

Installation:

Please read all instructions carefully.
Before you proceed to install, make sure that the power supply is turned off and remains off until installation is complete.
Please note that each part has been assigned a number.
Please proceed in a numerical order.

1. Fix the crossbar (01) on the installation 4" junction-box (J-box).
2. Connect the metal plate (02) and lamp body (05) with steel wire (04).
3. Make sure the positive and negative charges of wire match with lamp body (05) correctly, screw the connecting points with the junction caps.
4. Make sure the main wire is enough long and keep the rest of wire in the 4" J-box.
5. Fix the lamp body (02) on the crossbar (01) with screw caps (03).
6. As the crystal dressing instruction, hang the crystal parts.

The end!

Crystal Dressing Diagram



When dressing the chandelier with the crystals please remember to wear either rubber or cotton gloves. So as to prevent any damage or smudging on the crystals.

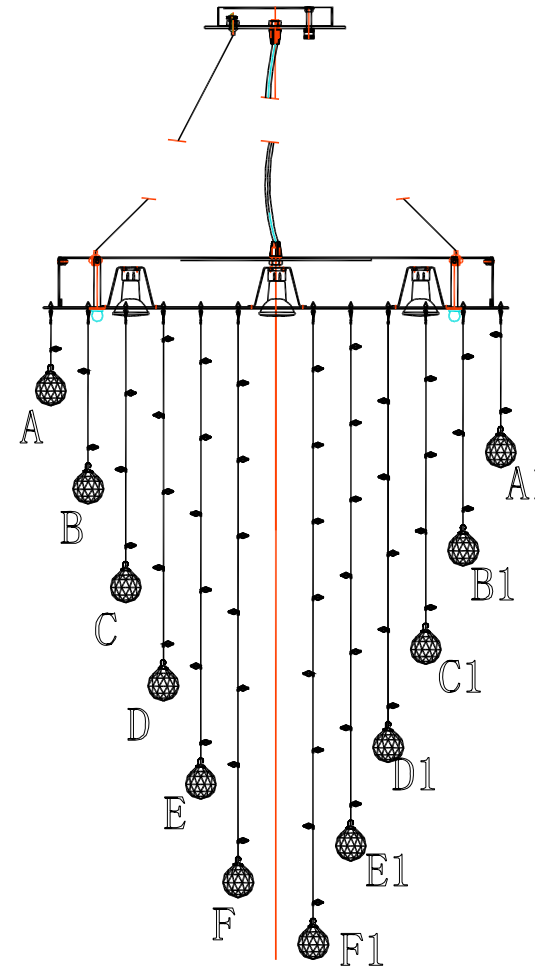

Crystal Dressing Instructions

When dressing the chandelier with the crystals please remember to wear either rubber or cotton gloves. So as to prevent any damage or smudging on the crystals.

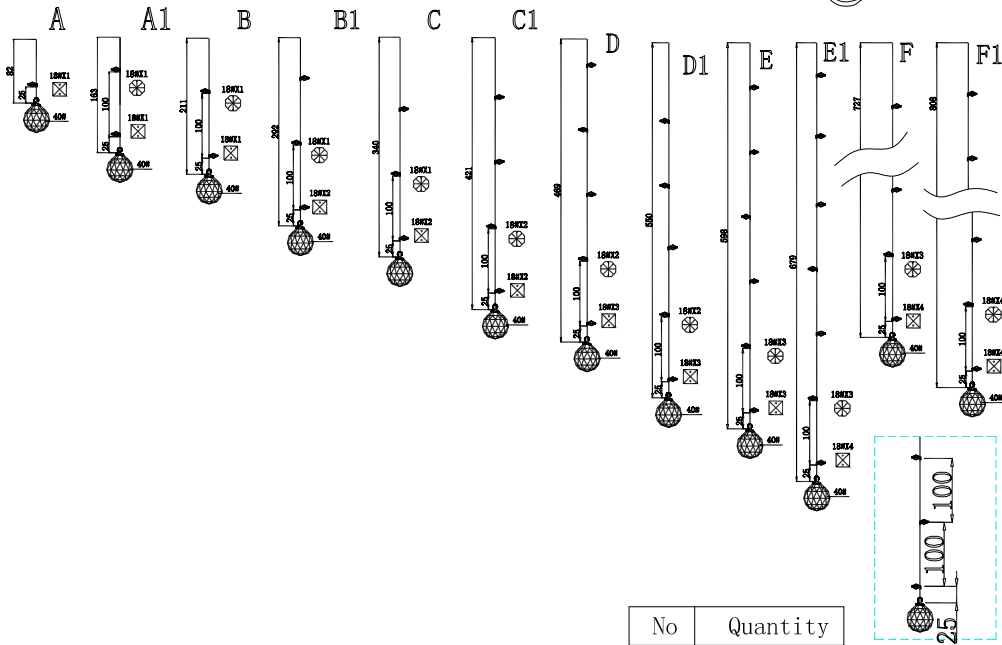
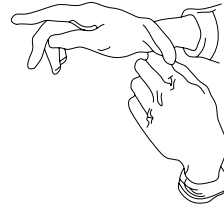

| No | Quantity | | |
|----|-----------|----|----------|
| A | 18strings | | |
| A1 | 18strings | | |
| B | 15strings | | |
| B1 | 15strings | | |
| C | 12strings | E | 6strings |
| C1 | 12strings | E1 | 6strings |
| D | 9strings | F | 3strings |
| D1 | 9strings | F1 | 3strings |